

# SOLACE

ACOUSTIC PANELS



RAFTERS



844.458.8115 | [heartlandcollection.us](http://heartlandcollection.us)





## RAFTERS

### Acoustical Open-ended Ceiling Hangers

Discover the epitome of clean lines with RAFTERS. Mix alternating heights, lengths and colors for that perfect aesthetic. Uniform heights can be used for a streamlined look. Also snaps into any Unistrut for straightforward, easy installation. Lengths can be fieldmodified to custom lengths.

Application	Ceiling Suspended			
	L	W	H	WEIGHT
<b>RAFTERS 2 in.</b>	96.0"	24"	2.25"	1.0 lbs.
<b>RAFTERS 3 in.</b>	96.0"	24"	3.25"	1.4 lbs.
<b>RAFTERS 4 in.</b>	96.0"	24"	4"	1.7 lbs.
<b>RAFTERS 5 in.</b>	96.0"	24"	5"	2.1 lbs.

\* Lengths can be field-modified

#### Hardware

Default: Aircraft Cable/Threaded Rod, Coupler Nut, Griplock, Hanger Bolt

Unistrut\*: Unistrut, Cone Nut Assembly, Threaded Rod/Aircraft Cable, Coupler Nut, Griplock

Drop Ceiling\*: T-Bar Clip/Magnet, Coupler Nut, Hanger Bolt, Grab Bracket

\* Available Upon Request

**Material Content** 9 mm 100% PET (55% recycled content)

**Flammability** ASTM E84 Class A or B

#### Acoustics - 2 inch no backer (Unistrut)

Frequency (Hz)	250	500	1K	2K	NRC
<b>NRC</b>	0.16	0.43	0.76	1.05	<b>0.60</b>
<b>Sabins per m<sup>2</sup></b>	11.48	31.35	55.55	76.55	

#### Acoustics - 5 inch no backer (Unistrut)

Frequency (Hz)	250	500	1K	2K	NRC
<b>NRC</b>	0.35	0.80	1.21	1.63	<b>1.00</b>
<b>Sabins per m<sup>2</sup></b>	24.87	56.75	85.63	115.66	

Test was conducted while product was in its actual installation setting.

All NRC testings assumes one face/one object and does not account for the product thickness.

#### Environment

Low VOC;  
Post-Consumer Recycled Content  
100% Recyclable

#### Installation

RAFTERS comes with 8ft long pre-assembled U-channel structures that easily install onto our custom designer Grab Brackets. Hardware includes Grab Brackets and Bracket Joiner. The ceiling fastener is provided by an installer based on ceiling type.

#### Country of Origin

USA

## Swatches

---



\* Due to the "heathered" effect of the material, slight and consistent variations in color may be present.

\*\* Specialty colors available upon request

## Dimensions

---

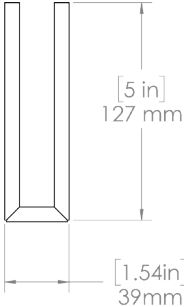
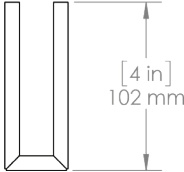
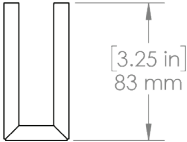
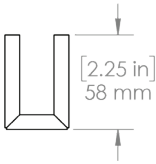
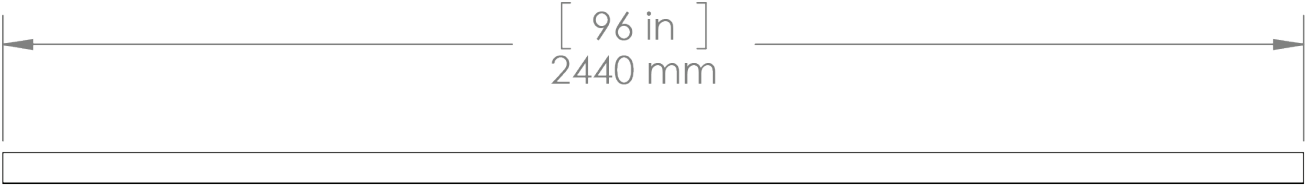



## Dimensions

---

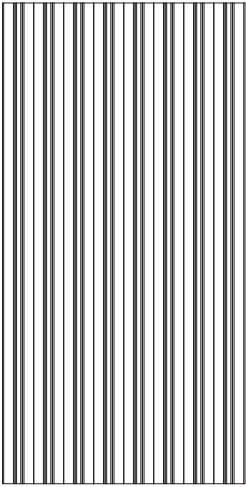
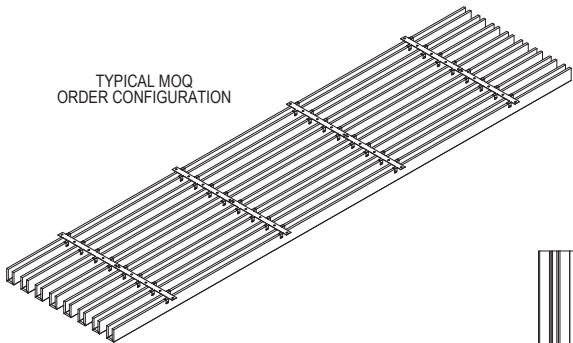
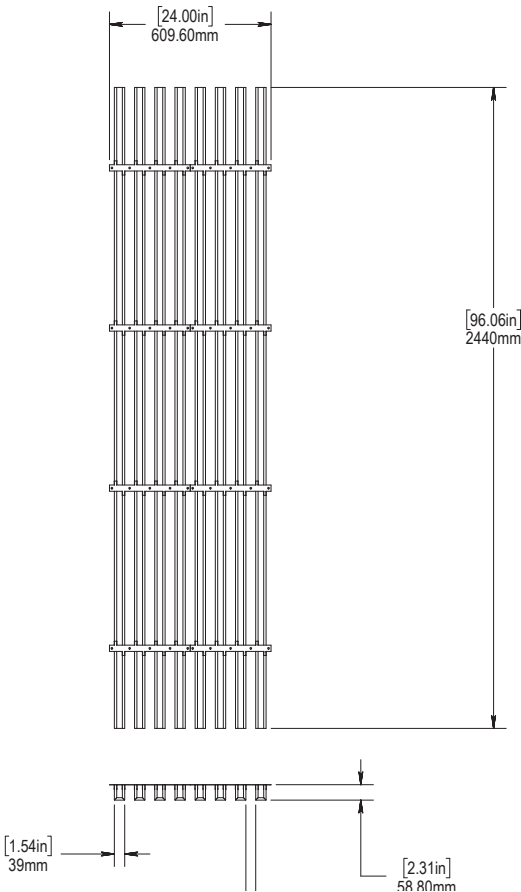

## Dimensions

---

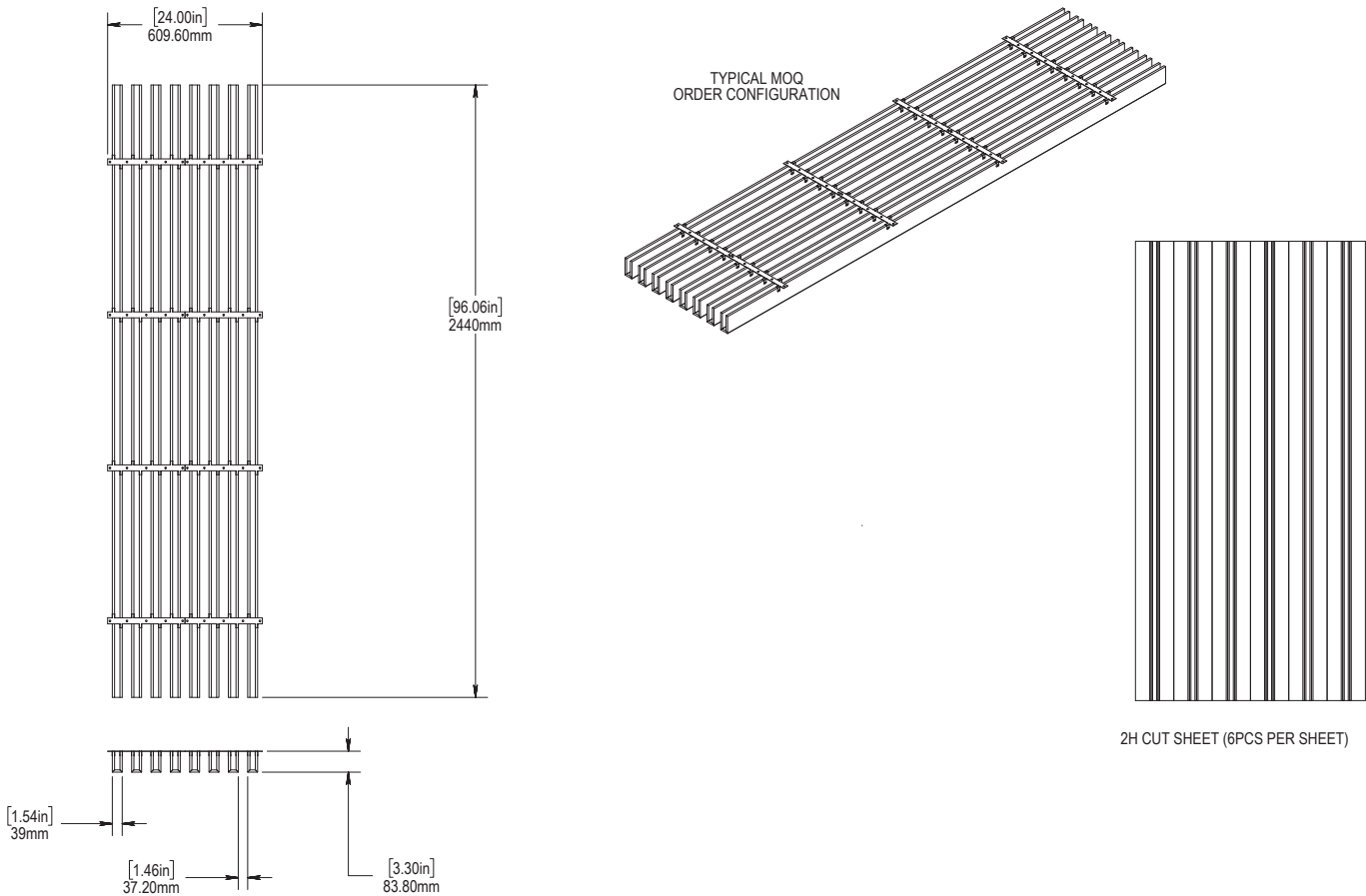

## Dimensions

---

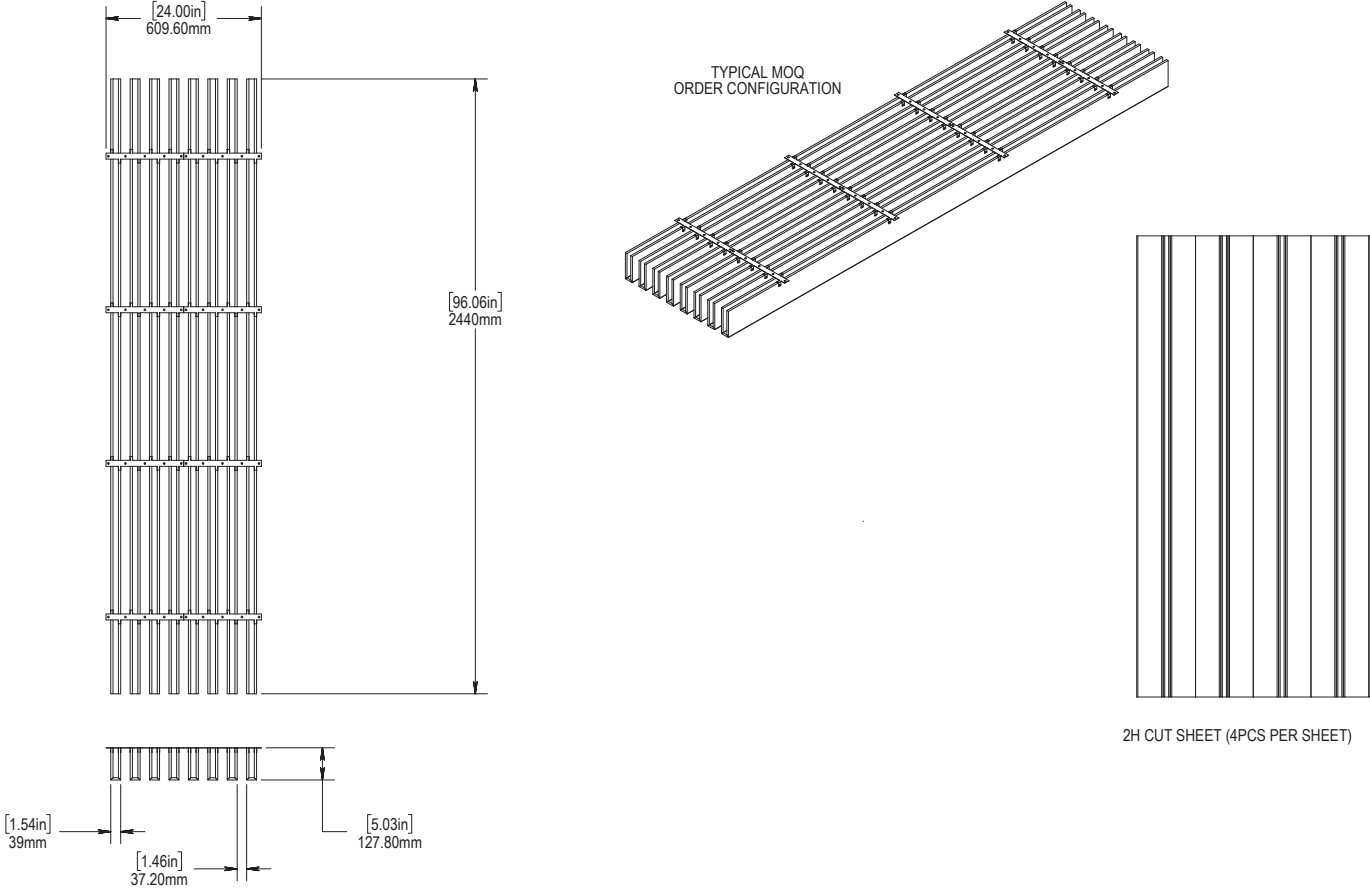

## Dimensions

---

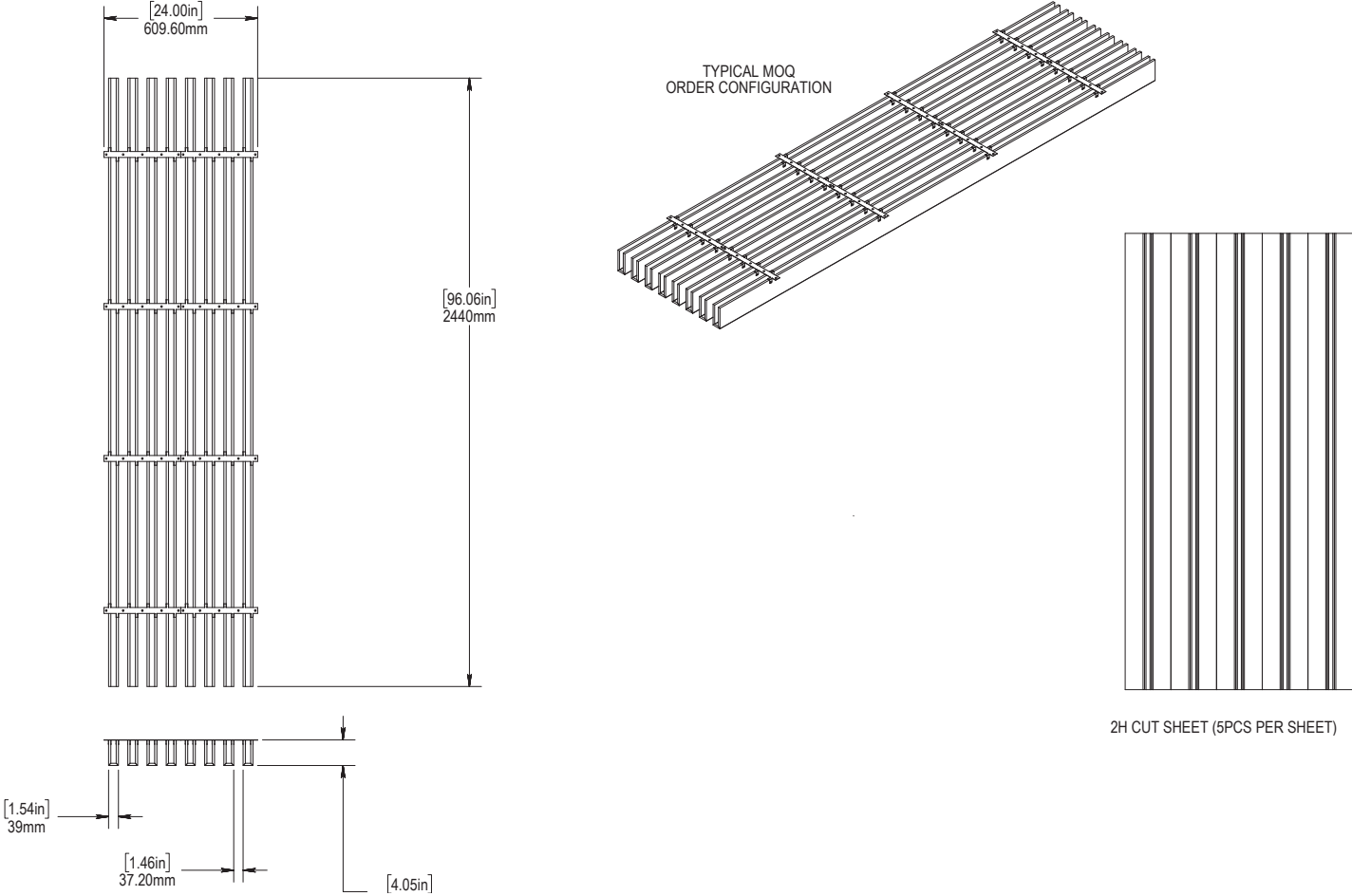



## Variable Height Layout & Hardware Details

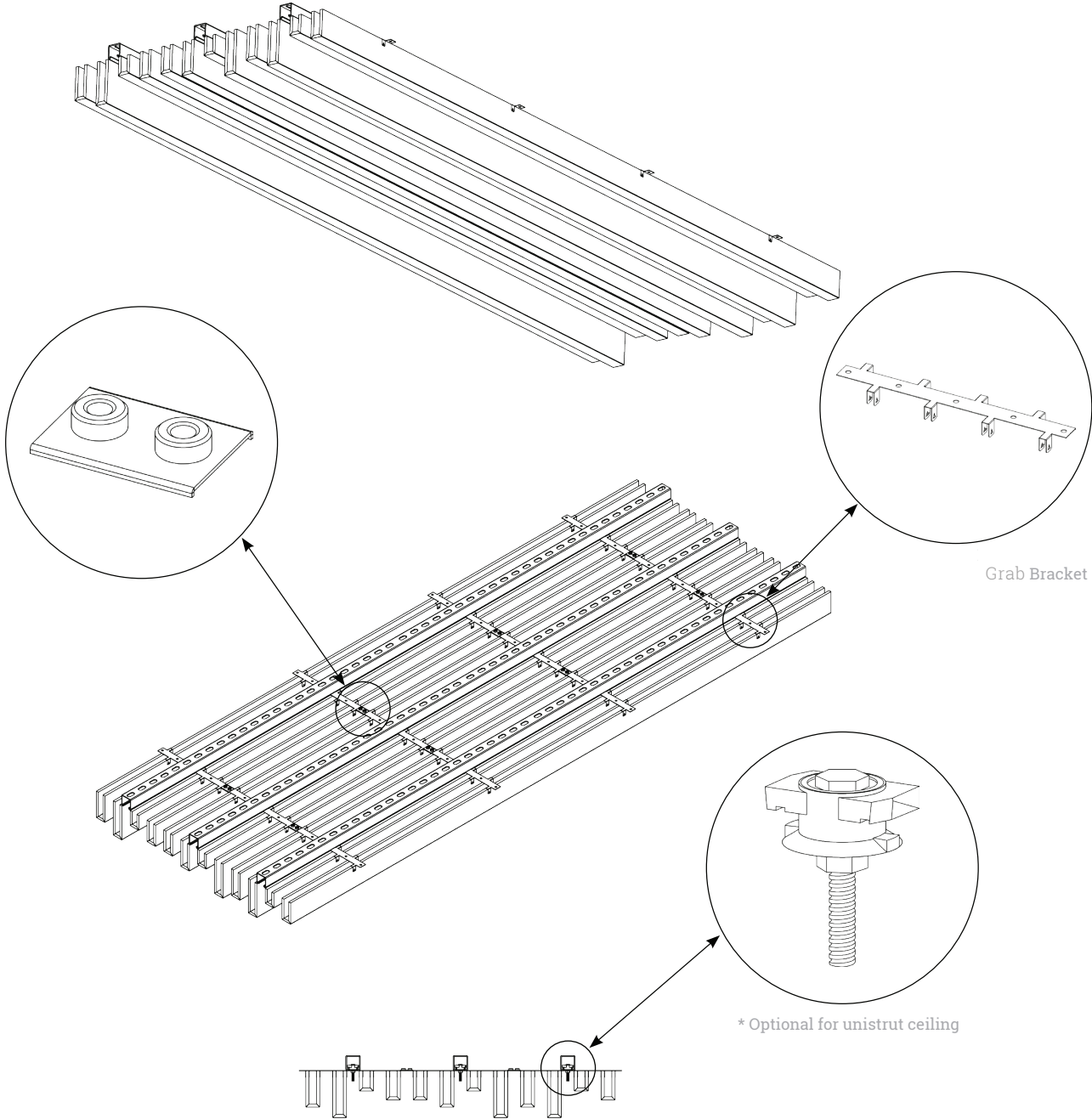

## Uniform Height Layout & Hardware Details

